

AN7560Z

BTL output power IC for car audio

■ Overview

The AN7560Z is an audio power IC developed as the sound output of car audio (35 W by 4-ch.). A capacitor and resistor to stop oscillation are built in between the output pin and GND so that a space saving of set is possible. Also, it incorporates a perfect muting circuit without shock noise so that a shock noise design under the set transient condition can be made easily when used together with its standby function. In addition, it incorporates various protection circuits to protect the IC from destruction by GND-open-shortcircuit to ground and power supply surge which are the important subject of power IC protection. This IC will largely contribute to a high reliability design of the equipment.

■ Features

- A pattern layout in which input and output pattern do not intersect each other on single-sided printed circuit board is possible.
- Incorporating various protection circuits (temperature, shortcircuit to V_{CC} , V_{CC} -open short circuit to V_{CC} , shortcircuit to GND, GND-open short circuit to GND, overvoltage, power supply surge, and ASO, etc.)
- Built-in standby function (shock noise-free when STB-on/off)
- Built-in muting function (shock noise-free when Mute-on/off)
- External components reduction
- Provided with beep sound input pin
- Equipped with auxiliary sound input pin

■ Applications

- Car stereo, miniature audio component, karaoke and other audio equipment.

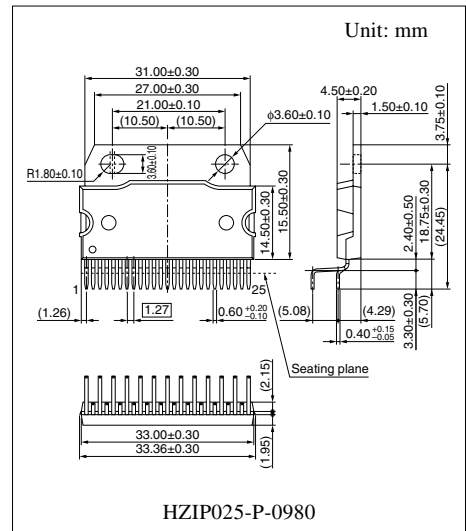

Note) The package of this product will be changed to lead-free type (HZIP025-P-0980B). See the new package dimensions section later of this datasheet.

■ Block Diagram

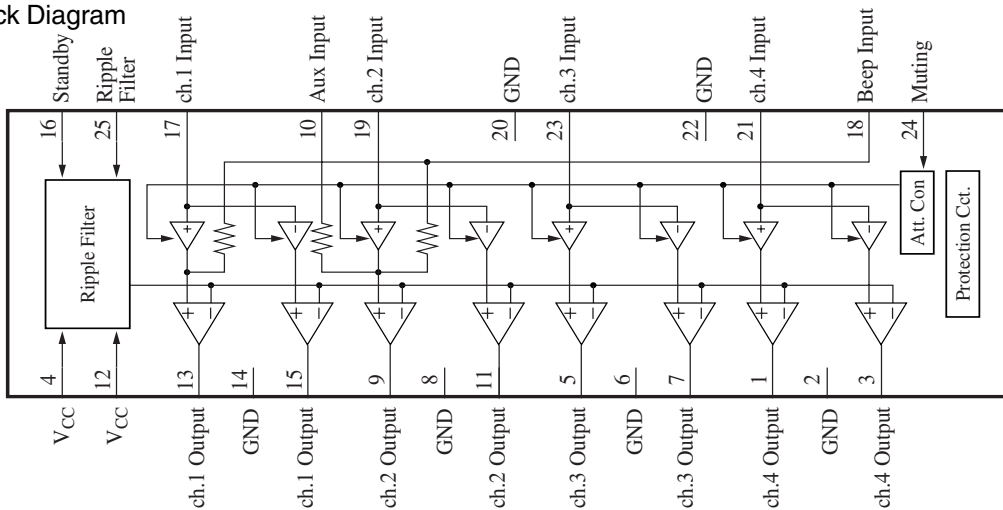

■ Pin Descriptions

Pin No.	Description	Pin No.	Description
1	ch.4 Output (+)	14	GND(Output ch.1)
2	GND (Output ch.4)	15	ch.1 Output (-)
3	ch.4 Output (-)	16	Standby
4	V _{CC}	17	ch.1 Input
5	ch.3 Output (+)	18	Beep Sound Input
6	GND(Output ch.3)	19	ch.2 Input
7	ch.3 Output (-)	20	GND (Input)
8	GND (Output ch.2)	21	ch.4 Input
9	ch.2 Output (+)	22	GND (Sub)
10	Auxiliary sound input	23	ch.3 Input
11	ch.2 Output (-)	24	Muting
12	V _{CC}	25	Ripple Filter
13	ch.1 Output (+)		

■ Absolute Maximum Ratings

Parameter	Symbol	Rating	Unit
Supply voltage *2	V _{CC}	25	V
Peak supply voltage *3	V _{surge}	65	V
Supply current	I _{CC}	12	A
Power dissipation *4	P _D	59	W
Operating ambient temperature *1	T _{opr}	-30 to +85	°C
Storage temperature *1	T _{stg}	-55 to +150	°C

Note) *1 : All items are at T_a = 25°C, except for the operating ambient temperature and storage temperature.

*2 : Without signal

*3 : Time = 0.2 s.

*4 : Power dissipation at T_a = 85°C.

■ Recommended Operating Range

Parameter	Symbol	Range	Unit
Supply voltage	V_{CC}	8.0 to 18.0	V

■ Electrical Characteristics at $V_{CC} = 13.2$ V, $f = 1$ kHz, $T_a = 25^\circ\text{C}$

Parameter	Symbol	Conditions	Min	Typ	Max	Unit
Quiescent current	I_{CQ}	$R_g = 10\text{ k}\Omega$, $R_L = 4\ \Omega$	—	300	450	mA
Standby current	I_{STB}	$R_g = 10\text{ k}\Omega$, $R_L = 4\ \Omega$	—	1	10	μA
Output noise voltage*1	V_{NO}	$R_g = 10\text{ k}\Omega$, $R_L = 4\ \Omega$	—	0.15	0.5	mV[rms]
Voltage gain	G_V	$V_{IN} = 40\text{ mV[rms]}$, $R_L = 4\ \Omega$	32	34	36	dB
Total harmonic distortion 1	THD1	$V_{IN} = 40\text{ mV[rms]}$, $R_L = 4\ \Omega$	—	0.05	0.2	%
Maximum output power 1	P_{O1}	THD = 10%, $R_L = 4\ \Omega$	16	19.5	—	W
Ripple rejection*1	RR	$R_g = 10\text{ k}\Omega$, $R_L = 4\ \Omega$ $V_R = 1\text{ V[rms]}$, $f_R = 1\text{ kHz}$	60	68	—	dB
Channel balance	CB	$V_{IN} = 40\text{ mV[rms]}$, $R_L = 4\ \Omega$	—	0	1	dB
Cross-talk	CT	$R_g = 10\text{ k}\Omega$, $R_L = 4\ \Omega$ $V_{IN} = 40\text{ mV[rms]}$	60	70	—	dB
Output offset voltage	V_{OFF}	$R_g = 10\text{ k}\Omega$, $R_L = 4\ \Omega$	-250	0	250	mV
Muting effect*1	MT	$V_{IN} = 40\text{ mV[rms]}$, $R_L = 4\ \Omega$	70	86	—	dB
Input impedance	Z_I	$V_{IN} = \pm 0.3\ V_{DC}$	24	30	36	k Ω
Shock noise*2	V_S	$R_g = 10\text{ k}\Omega$, $R_L = 4\ \Omega$, $V_{MUTE} = 5\text{ V}$ $V_{STB} = \text{on/off}$, 50 Hz HPF	-100	0	100	mV[0-P]
Total harmonic distortion 2	THD2	$V_{IN} = 20\text{ mV[rms]}$, $f_{IN} = 20\text{ kHz}$ $R_g = 10\text{ k}\Omega$, $R_L = \infty$	—	0.1	0.5	%
Mute On threshold voltage	MT_{ON}	$V_{IN} = 40\text{ mV[rms]}$, $R_L = 4\ \Omega$	4	—	—	V
Mute Off threshold voltage	MT_{OFF}	$V_{IN} = 40\text{ mV[rms]}$, $R_L = 4\ \Omega$	—	—	0.8	V
Maximum output power 2	P_{O2}	$V_{IN} = 1\text{ V[rms]}$, $R_L = 4\ \Omega$	—	28	—	W
Maximum output power 3	P_{O3}	$V_{CC} = 14.4\text{ V}$, THD = 10%, $R_L = 4\ \Omega$	—	21	—	W
Maximum output power 4	P_{O4}	$V_{CC} = 14.4\text{ V}$, $V_{IN} = 1\text{ V[rms]}$, $R_L = 4\ \Omega$	—	34	—	W

Note) *1 : Measurement using a bandwidth 15 Hz to 30 kHz (12 dB/OCT) filter.

*2 : Change over the standby terminal at the time shown in the right.

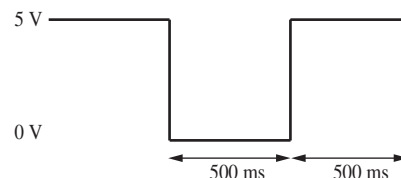

■ Technical Information

1. $P_D - T_a$ curves of HZIP025-P-0980

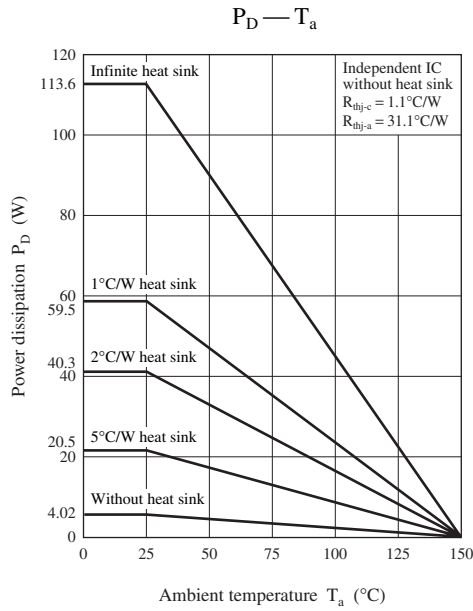

2. Main characteristics

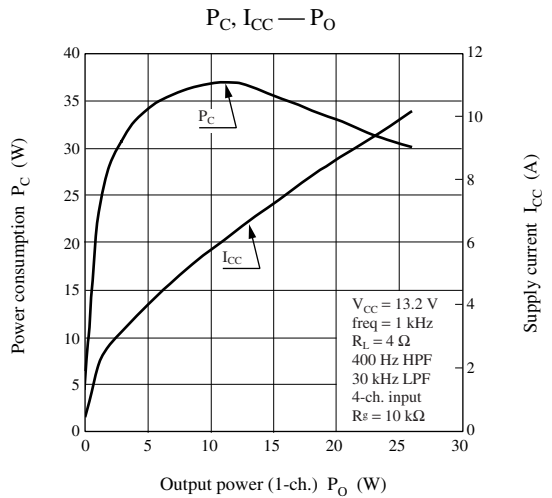
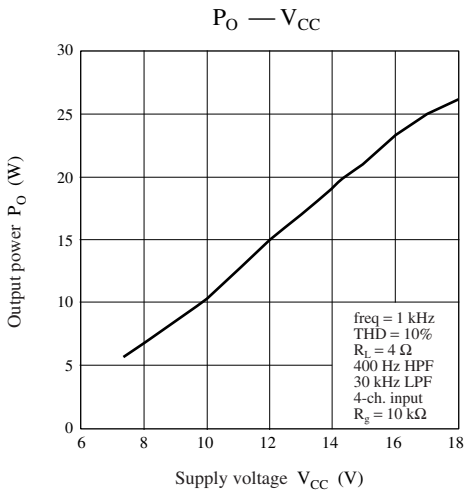

■ Technical Information (continued)

2. Main characteristics (continued)

P_O , THD — V_{IN}

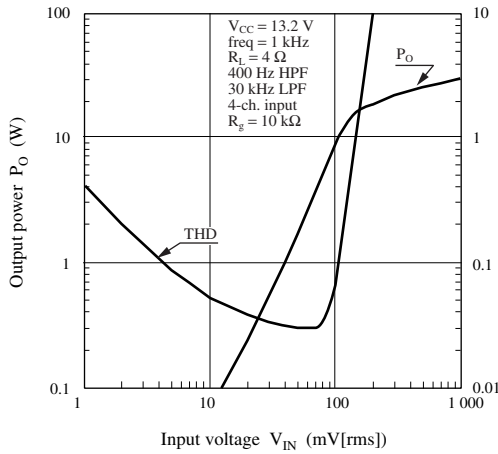

THD — V_{IN}

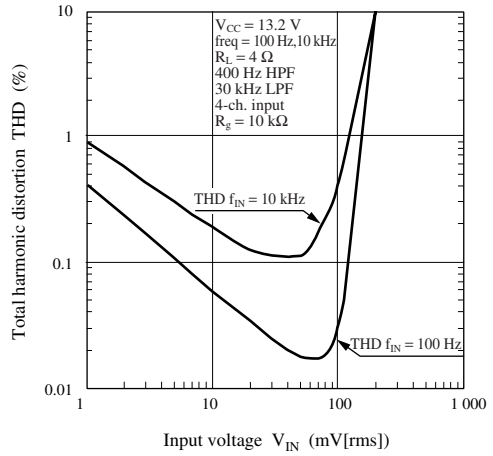

G_V , P_O — freq

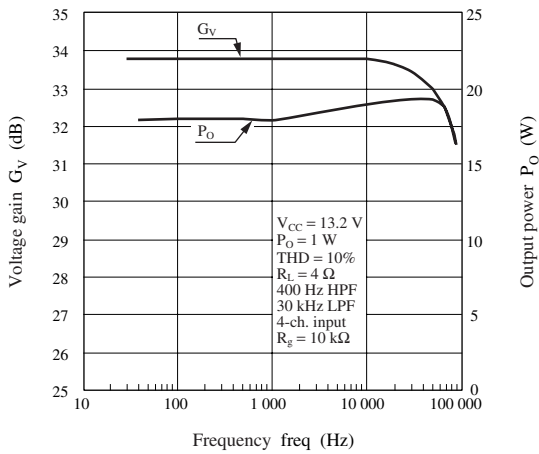

THD — freq

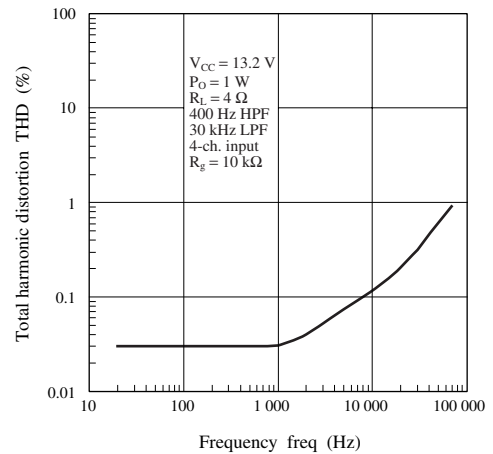

G_V , THD — V_{CC}

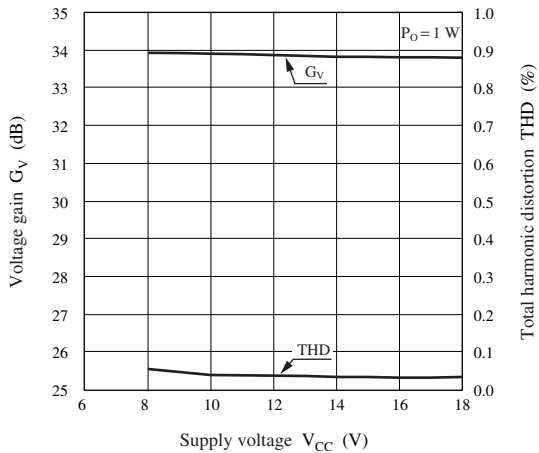

I_{CQ} , I_{STB} — V_{CC}

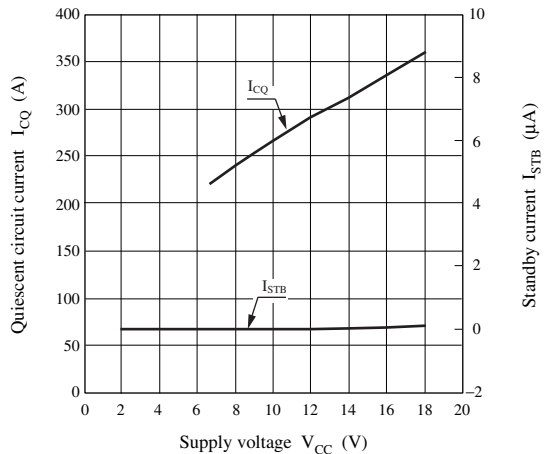

■ Technical Information (continued)

2. Main characteristics (continued)

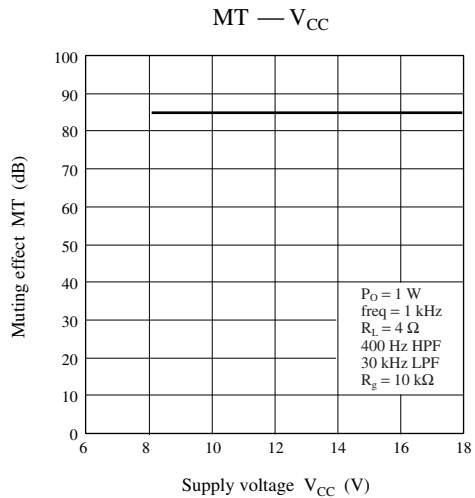
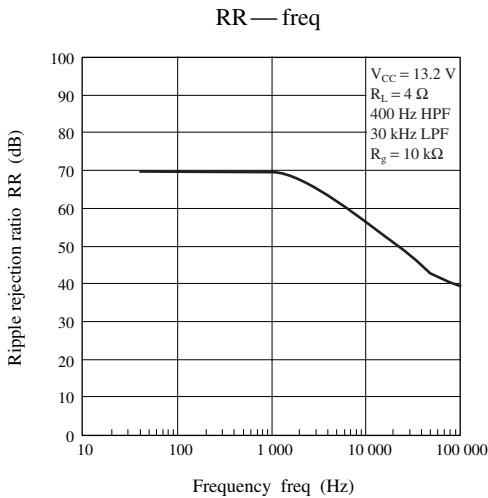
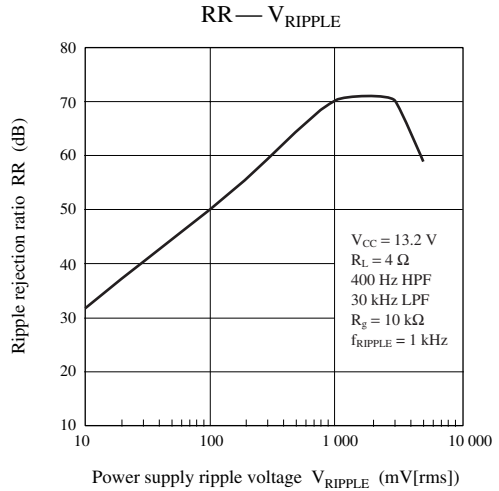
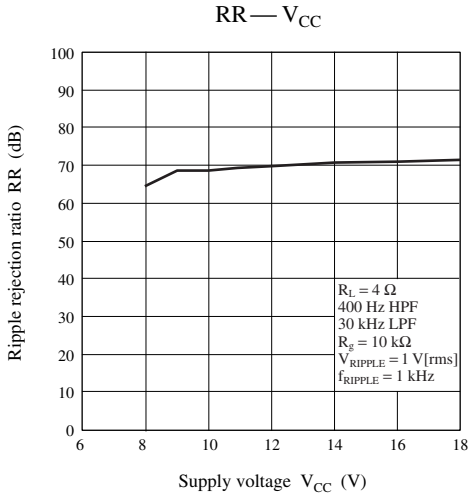
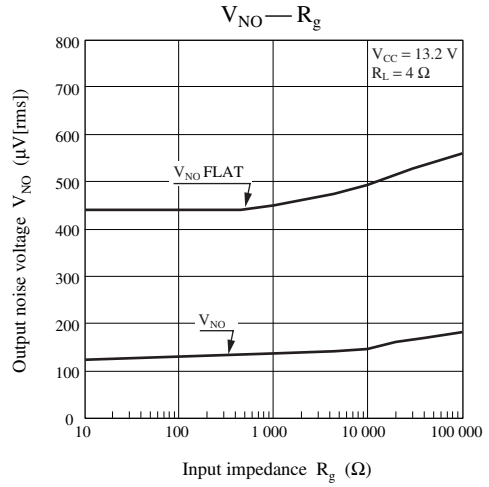
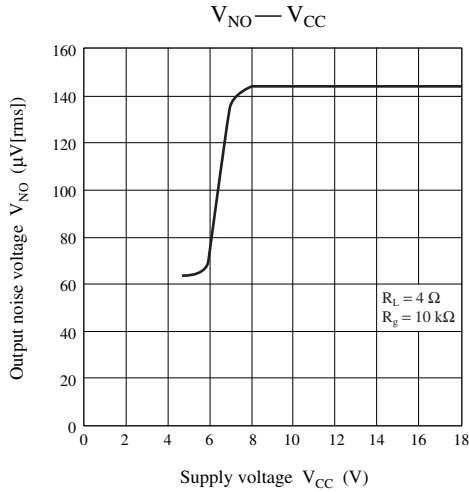

■ Technical Information (continued)

2. Main characteristics (continued)

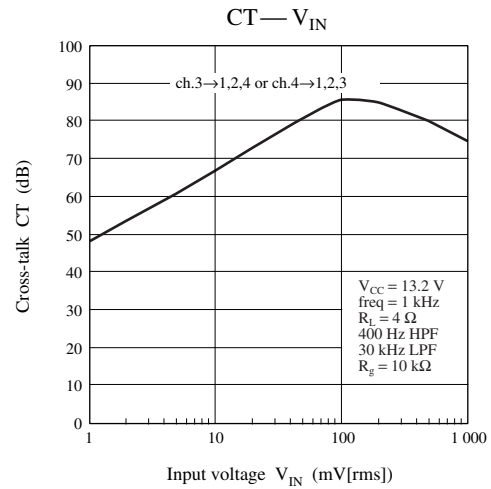
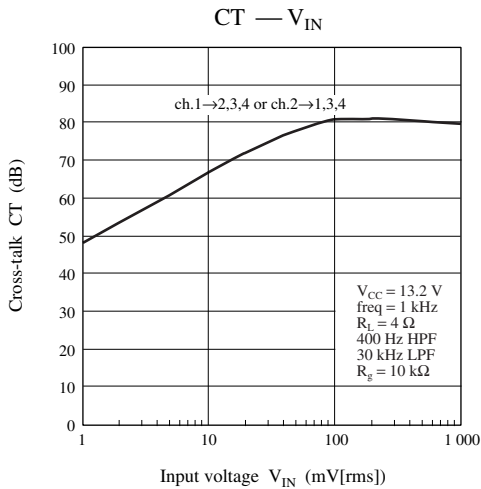
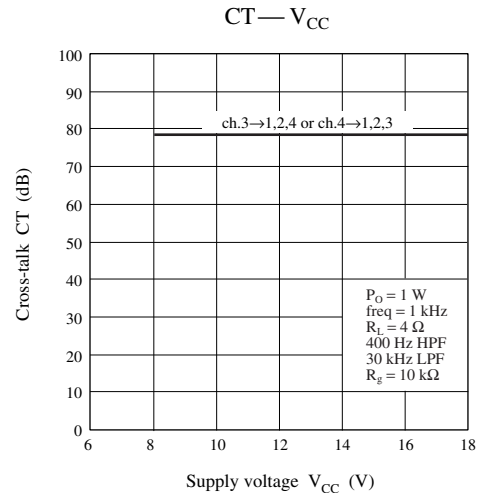
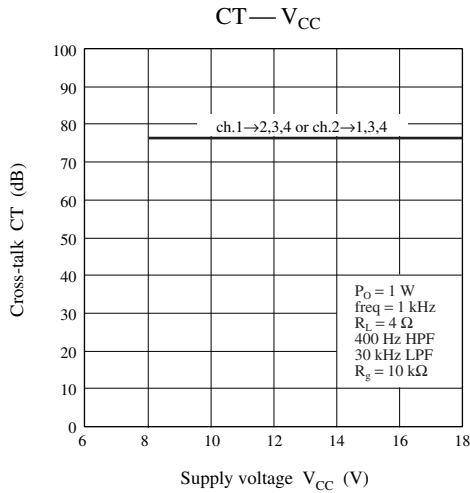
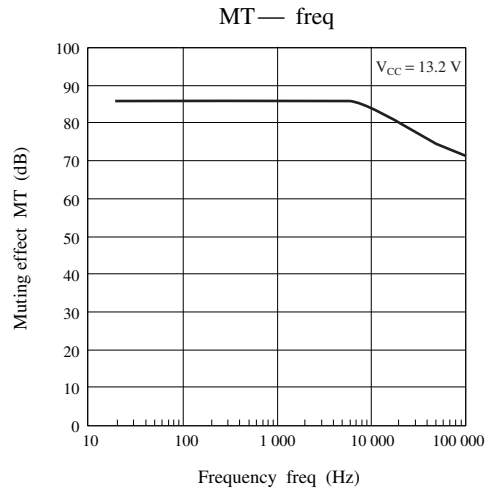
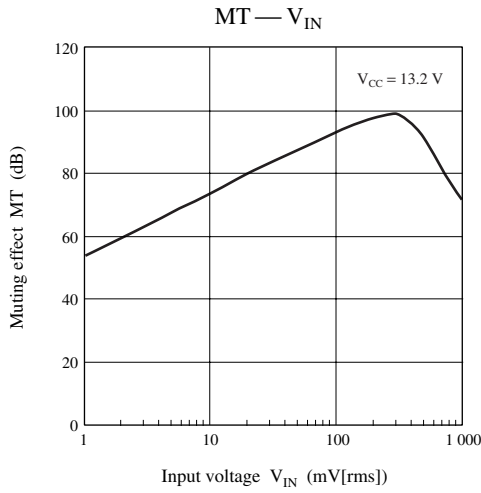

■ Technical Information (continued)

2. Main characteristics (continued)

CT — freq

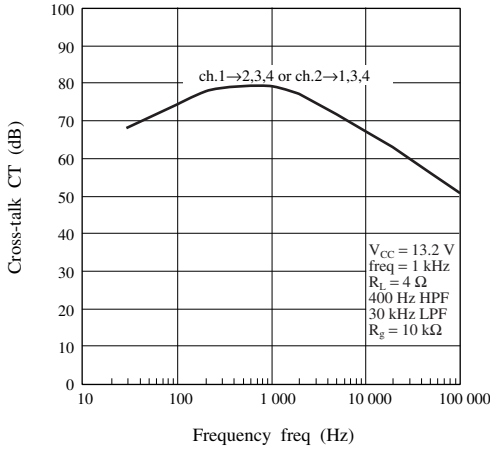

CT — freq

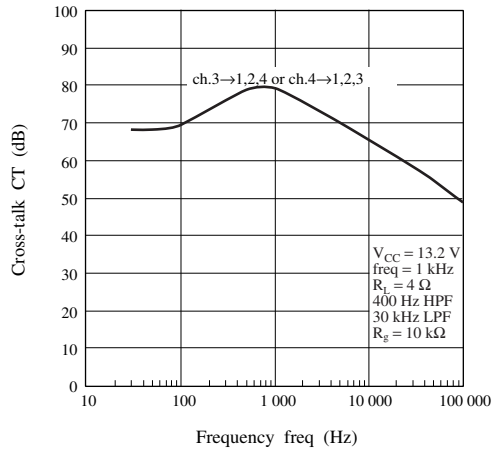

V_{OFFSET} — V_{CC}

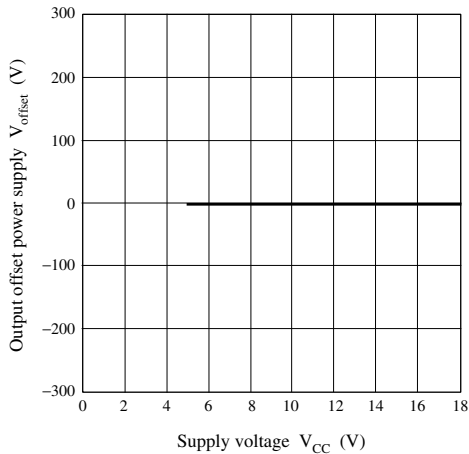

I_{CQ} — V_{STB}

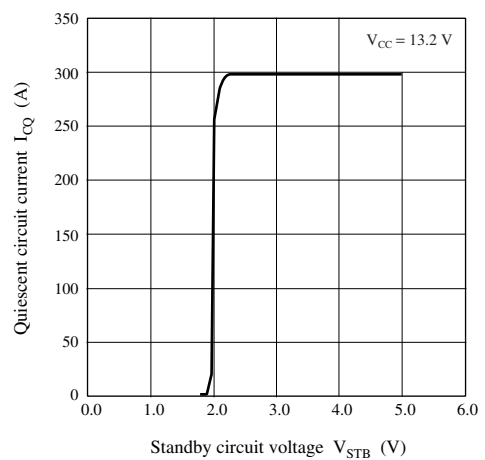

MT — V_{MUTE}

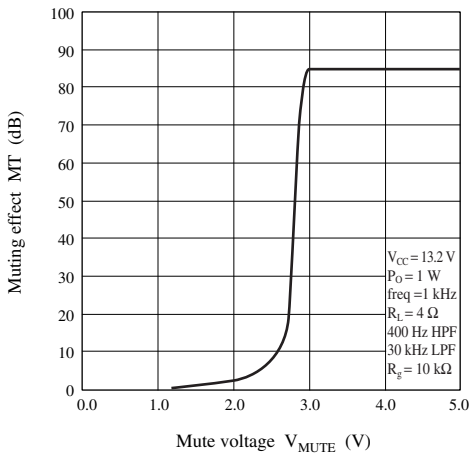

■ Technical Information (continued)

3. Printed circuit board layout example

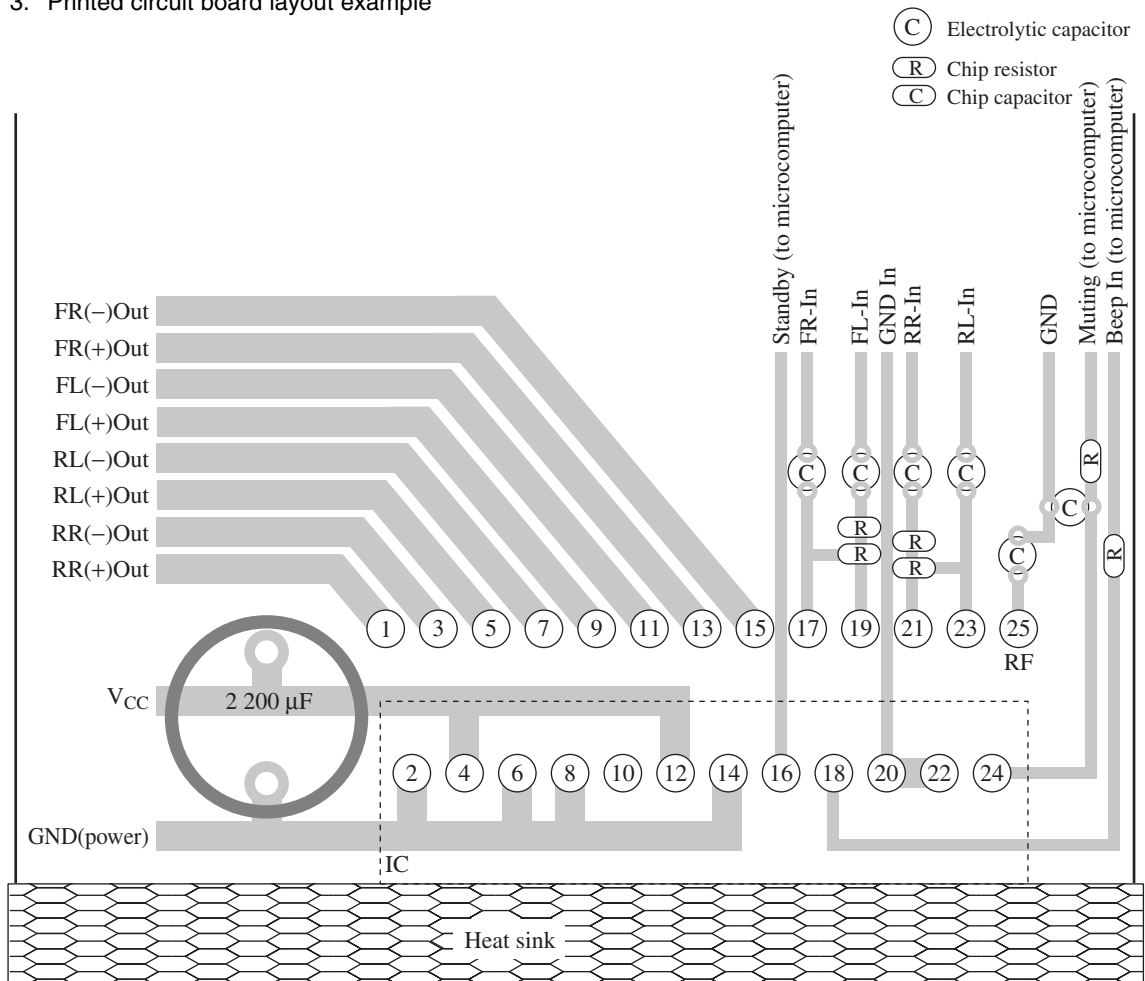

■ Application Circuit Example

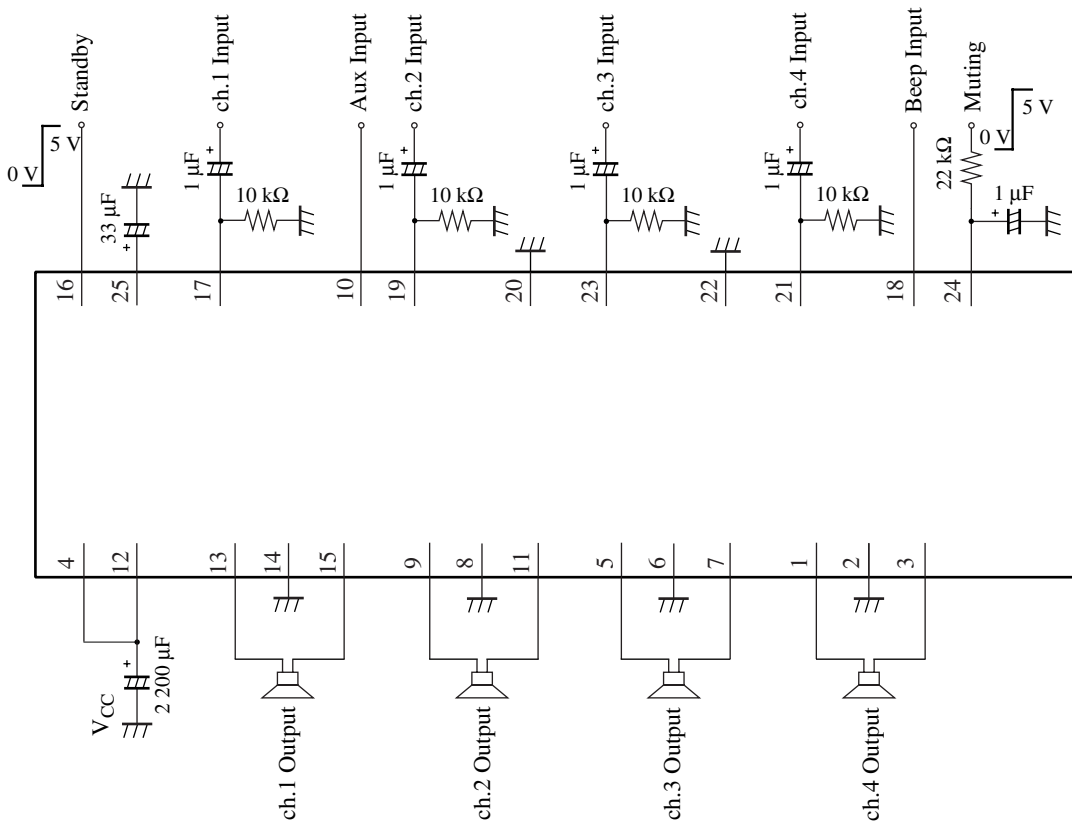

■ New Package Dimensions (Unit: mm)

- HZIP025-P-0980B (Lead-free package)

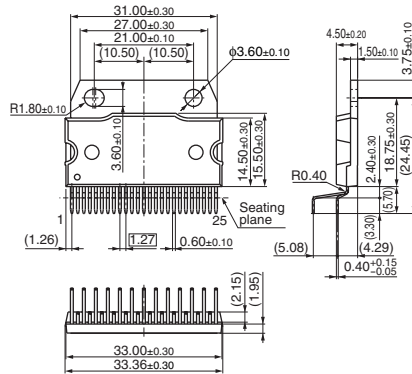

Request for your special attention and precautions in using the technical information and semiconductors described in this material

- (1) An export permit needs to be obtained from the competent authorities of the Japanese Government if any of the products or technologies described in this material and controlled under the "Foreign Exchange and Foreign Trade Law" is to be exported or taken out of Japan.
- (2) The technical information described in this material is limited to showing representative characteristics and applied circuit examples of the products. It does not constitute the warranting of industrial property, the granting of relative rights, or the granting of any license.
- (3) The products described in this material are intended to be used for standard applications or general electronic equipment (such as office equipment, communications equipment, measuring instruments and household appliances).
Consult our sales staff in advance for information on the following applications:
 - Special applications (such as for airplanes, aerospace, automobiles, traffic control equipment, combustion equipment, life support systems and safety devices) in which exceptional quality and reliability are required, or if the failure or malfunction of the products may directly jeopardize life or harm the human body.
 - Any applications other than the standard applications intended.
- (4) The products and product specifications described in this material are subject to change without notice for reasons of modification and/or improvement. At the final stage of your design, purchasing, or use of the products, therefore, ask for the most up-to-date Product Standards in advance to make sure that the latest specifications satisfy your requirements.
- (5) When designing your equipment, comply with the guaranteed values, in particular those of maximum rating, the range of operating power supply voltage and heat radiation characteristics. Otherwise, we will not be liable for any defect which may arise later in your equipment.
Even when the products are used within the guaranteed values, redundant design is recommended, so that such equipment may not violate relevant laws or regulations because of the function of our products.
- (6) When using products for which dry packing is required, observe the conditions (including shelf life and after-unpacking standby time) agreed upon when specification sheets are individually exchanged.
- (7) No part of this material may be reprinted or reproduced by any means without written permission from our company.

Please read the following notes before using the datasheets

- A. These materials are intended as a reference to assist customers with the selection of Panasonic semiconductor products best suited to their applications.
Due to modification or other reasons, any information contained in this material, such as available product types, technical data, and so on, is subject to change without notice.
Customers are advised to contact our semiconductor sales office and obtain the latest information before starting precise technical research and/or purchasing activities.
- B. Panasonic is endeavoring to continually improve the quality and reliability of these materials but there is always the possibility that further rectifications will be required in the future. Therefore, Panasonic will not assume any liability for any damages arising from any errors etc. that may appear in this material.
- C. These materials are solely intended for a customer's individual use.
Therefore, without the prior written approval of Panasonic, any other use such as reproducing, selling, or distributing this material to a third party, via the Internet or in any other way, is prohibited.